

## LED Knuckle Mount Flood Light Series



**Knuckle Mount**



**U-Bracket Mount**

### FEATURES

- IP65 rated
- Easy installation and maintenance
- Corrosion and rust proof
- Semi cut-off
- 50,000 hours lifetime

### SUITABLE APPLICATIONS

- Warehouses
- Stadiums
- Factories
- Parking Lots
- Shopping Malls
- Supermarkets
- Logistic Centers
- Auto dealerships

**Special Order:**

- Other CCTs

**CONSTRUCTION:**

Heavy die-cast aluminum housing with polyester powder-coated finish. Integral secondary heat sink to optimize thermal transfer and maximize performance of the LEDs. Driver is mounted in direct contact with the casting for low operating temperature.

**ELECTRICAL:**

Available as 120-277V input. -20°C to 50°C

**INSTALLATION & MOUNTING:**

Knuckle mount or U-Bracket.

**OPTICAL SYSTEM:**

Philips Lumiled 3030 LED chips. High quality tempered glass optics. 120° beam angle.

**WARRANTY:**

5-year limited warranty. Actual performance may differ as a result of end-user environment and application.



MODEL NUMBER – 5,000K	WATTAGE	LUMENS	EFFICACY	CRI	POWER FACTOR	THD	REPLACES
LOD-KFL-20W-50K-LV-V11	20W	2,080LM	104LM/W	80	0.9	18%	50W
LOD-KFL-30W-50K-LV-V11	30W	3,050LM	101.67LM/W	80	0.96	12.8%	75W
LOD-KFL-45W-50K-LV-V11	45W	5,670LM	126LM/W	70	0.9	20%	150W

Series	Wattage	Color Temperature	Voltage
LOD-KFL	20W 30W 45W	5000K	LV = 120-277V

## MEASUREMENTS

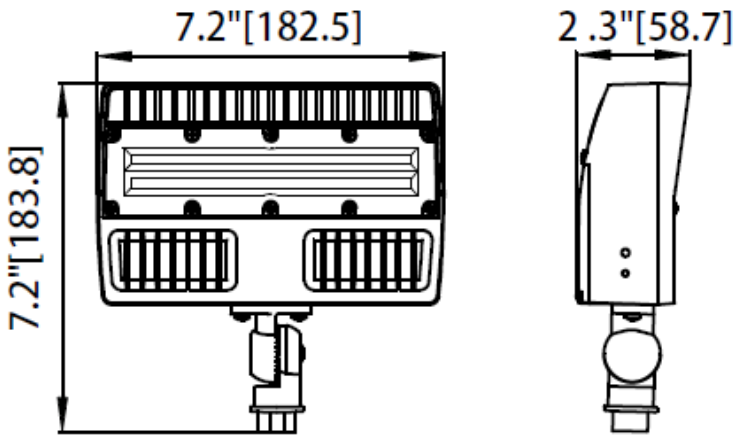

Knuckle Mount

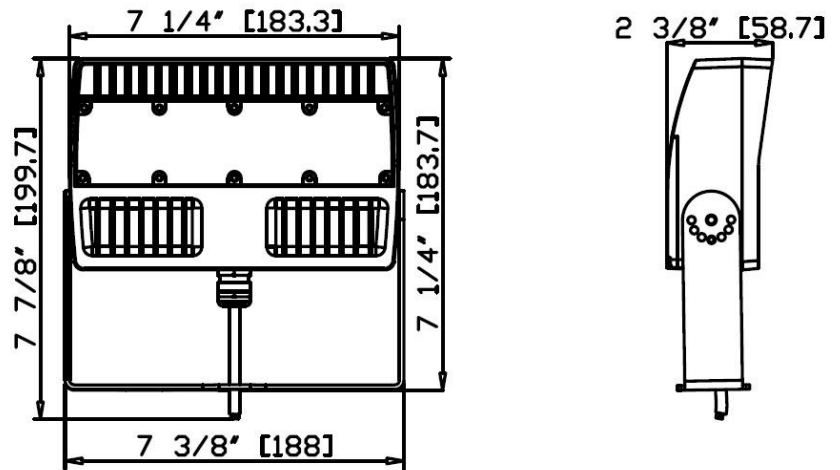

U-Bracket Mount

MODEL	QUANTITY	WEIGHT	UPC CODE
LOD-KFL-20W-50K-LV-V11 (Knuckle Mount)	1	2.10 lbs	00810050940290
LOD-KFL-20W-50K-LV-V11 (U-Bracket Mount)	1		00810050940306
LOD-KFL-30W-50K-LV-V11 (Knuckle Mount)	1	2.10 lbs	00810050940313
LOD-KFL-30W-50K-LV-V11 (U-Bracket Mount)	1		00810050940320
LOD-KFL-45W-50K-LV-V11 (Knuckle Mount)	1	2.35 lbs	00810050940337
LOD-KFL-45W-50K-LV-V11 (U-Bracket Mount)	1		00810050940344

## 20W

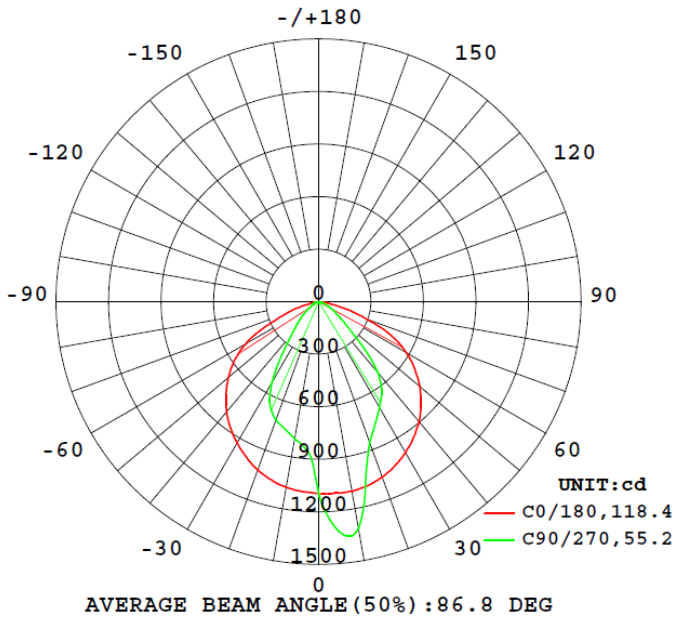

Flux out: 692.2 lm

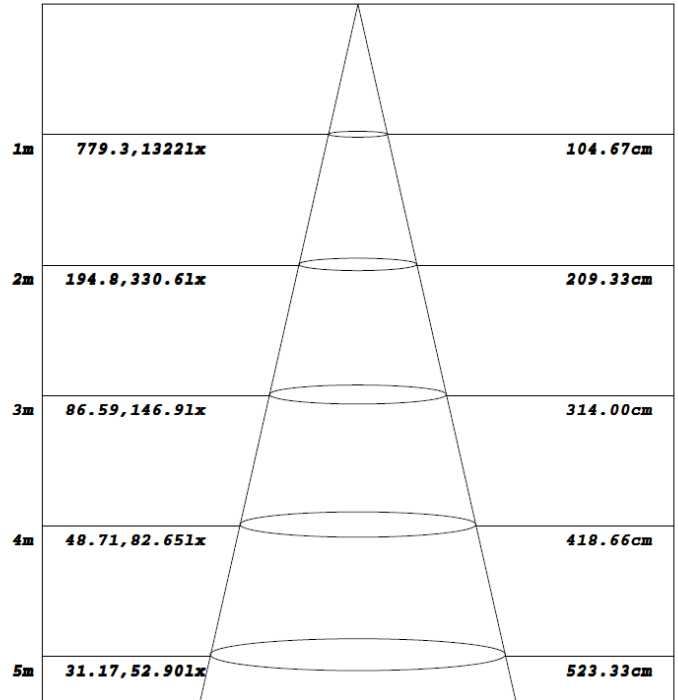

Note: The Curves indicate the illuminated area and the average illumination when the luminaire is at different distance.

## 30W

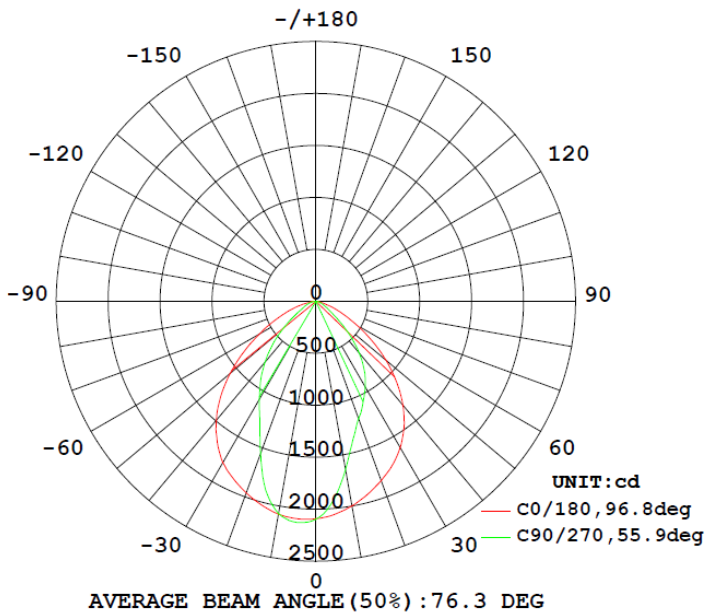

Flux out: 1222 lm

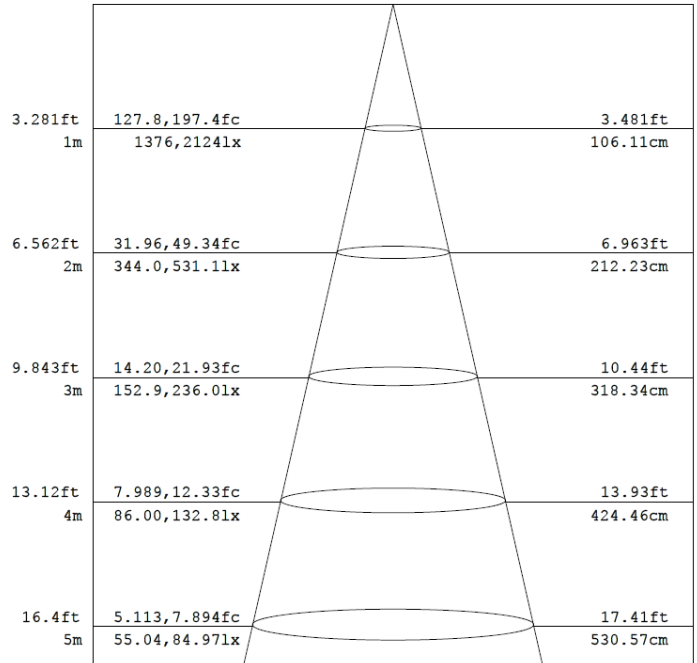

Note: The Curves indicate the illuminated area and the average illumination when the luminaire is at different distance.

## 45W

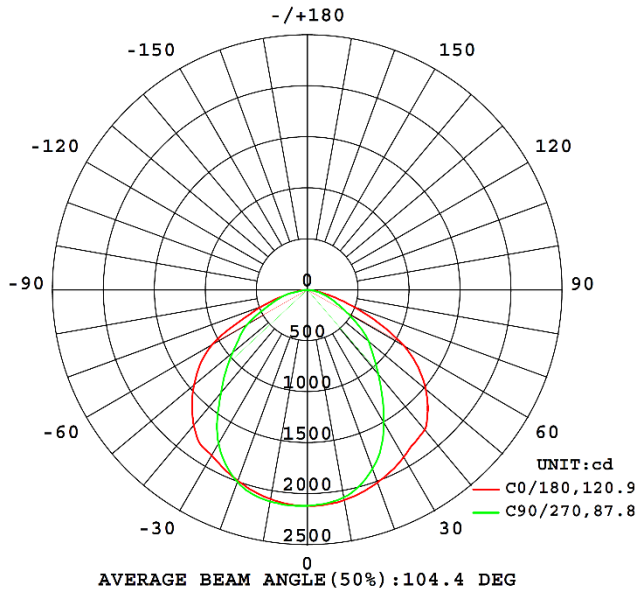

Flux out: 3041 lm

1m	1038, 2120lx	192.43cm
2m	259.5, 530.1lx	384.87cm
3m	115.3, 235.6lx	577.30cm
4m	64.88, 132.5lx	769.74cm
5m	41.52, 84.81lx	962.17cm
6m	28.83, 58.90lx	1154.61cm
7m	21.18, 43.27lx	1347.04cm
8m	16.22, 33.13lx	1539.47cm
9m	12.82, 26.18lx	1731.91cm
10m	10.38, 21.20lx	1924.34cm

Height      Avg, Emax      Angle: 87.79deg      Diameter

Note: The Curves indicate the illuminated area and the average illumination when the luminaire is at different distance.

