

LEDone[®]

Multi Watt Multi CCT Backlit Panel Series Installation Guide

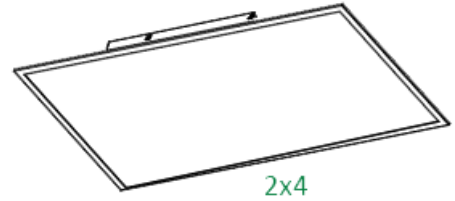
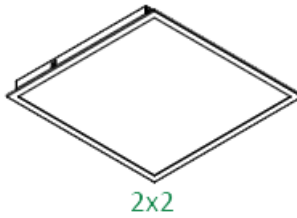
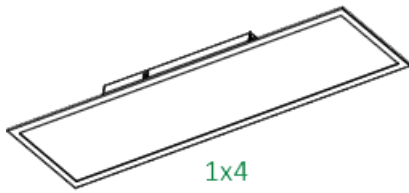

SAFETY INSTRUCTIONS: Read instructions carefully before attempting to install fixture.

- Fixture must be wired in accordance with the National Electrical Code and all applicable local codes.
- Proper grounding is required for safety.
- This product must be installed in accordance with the applicable installations code by a person familiar with the construction and operation of the product and the hazards involved.

CAUTION: Risk of fire

- **WARNING:** Suitable for 9/16" or 15/16" flat T-Grid in both insulated and non-insulated ceilings. Access above ceiling required.
- **WARNING:** Do NOT handle energized fixture when hands are wet, when standing on wet or damp surfaces or in water.
- **WARNING:** Vapor barrier must be suitable for 90°C.
- **WARNING:** Fixture to be independently supported to building structure.

CLEANING & MAINTENANCE:

CAUTION: Be sure the fixture temperature is cool enough to touch. Do NOT clean or maintain while the fixture is energized.

1. Clean frosted polystyrene lens and fixture with non-abrasive cleaning solution.
2. Do NOT open fixture to clean the LEDs. Do NOT touch the LEDs.

Note: These instructions do not cover all details or variation in equipment, nor do they provide for every possible situation during installation, operation or maintenance.

RECESSED CEILING MOUNTING:

The fixture is suitable only for INDOOR RECESSED CEILING application.

Above ceiling access required.

To mount in an insulated or non-insulated ceiling: 9/16" or 15/16" exposed flat T-Grid ceiling follow the steps below.

1. Firmly bend the pre-installed grid clips (up and out as shown in Fig. 1).
2. Rotate and slide the fixture as required to fit through the T-Grid bar and place it as indicated by the directional arrow as shown in Fig. 2. Secure the fixture to the see T-Grid bar.

Fig. 1

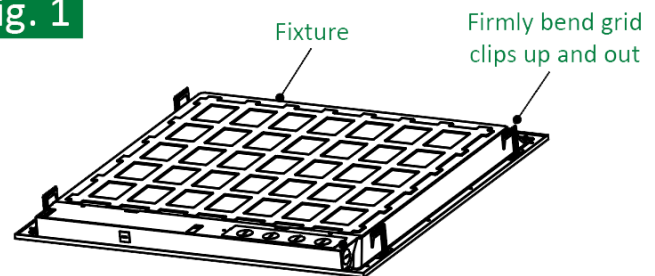
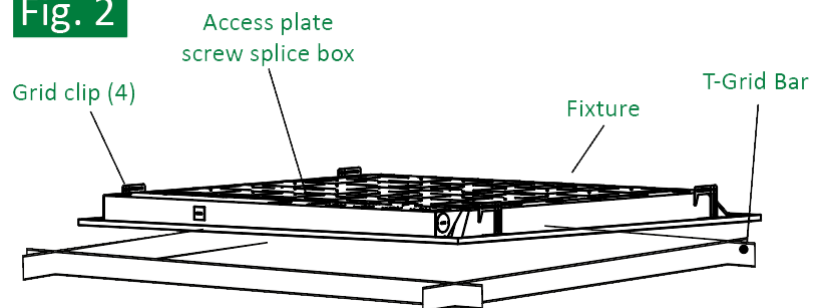

Fig. 2



3. Support wires are required by installation codes. Support the fixture to the building structure with support wires (supplied by others) through the grid clip hole as shown in Fig. 3.

4. Make sure that the orientation of the splice box and access plate faces an accessible tile to make electrical splices.

5. Loosen access plate screw and remove the access plate knock out appropriate conduit knockouts on the access plate to route input conduit. Use appropriate conduit connectors as required by code (Fig. 4).

6. Connect wires as shown in wiring diagram (Fig. 5) Push all wires back into the splice box. Use appropriate UL-approved wire connectors as required by code to complete wiring. Be careful not to pinch wires.

WARNING: To prevent wiring damage or abrasion do not expose wiring to edges of sheet metal or other sharp objects.

7. Replace access plate and tighten access plate screw.

Fig. 3

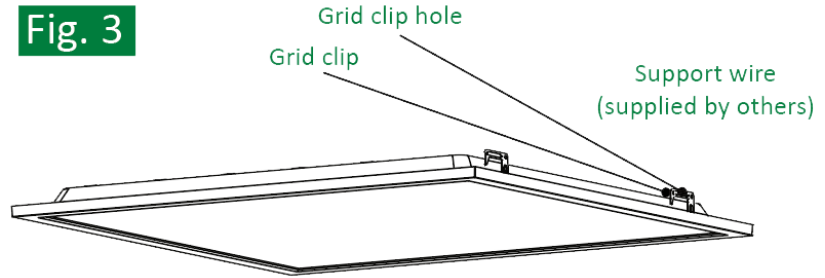

Fig. 4

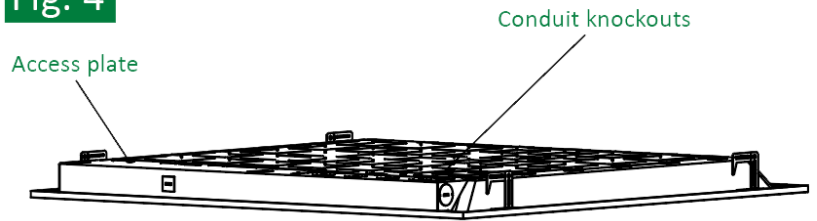
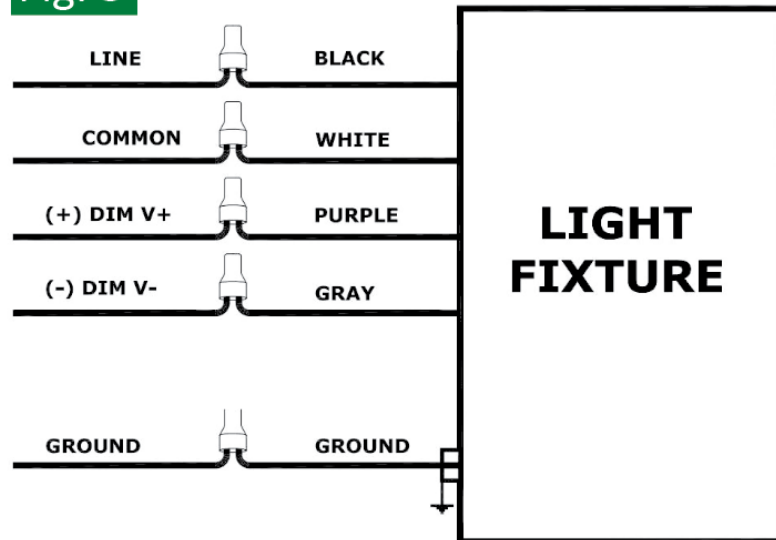

Fig. 5



WIRING INSTRUCTIONS:

Universal voltage driver permits operation at 120V through 277V. (See Fig.5)

1. Connect the **black** fixture lead to the **LINE** supply lead.
2. Connect the **white** fixture lead to the **COMMON** supply lead.
3. Connect the **GROUND** wire from fixture to supply ground.

TROUBLESHOOTING:

1. Check that the LINE voltage at fixture is correct. Refer to the wiring directions.
2. Is the fixture grounded properly?